

RN42221MUK Rev4

morphy richards[®]
smart ideas for your home



POWER STEAM ELITE  **Steam Generator**

 Please read and keep these instructions for future use

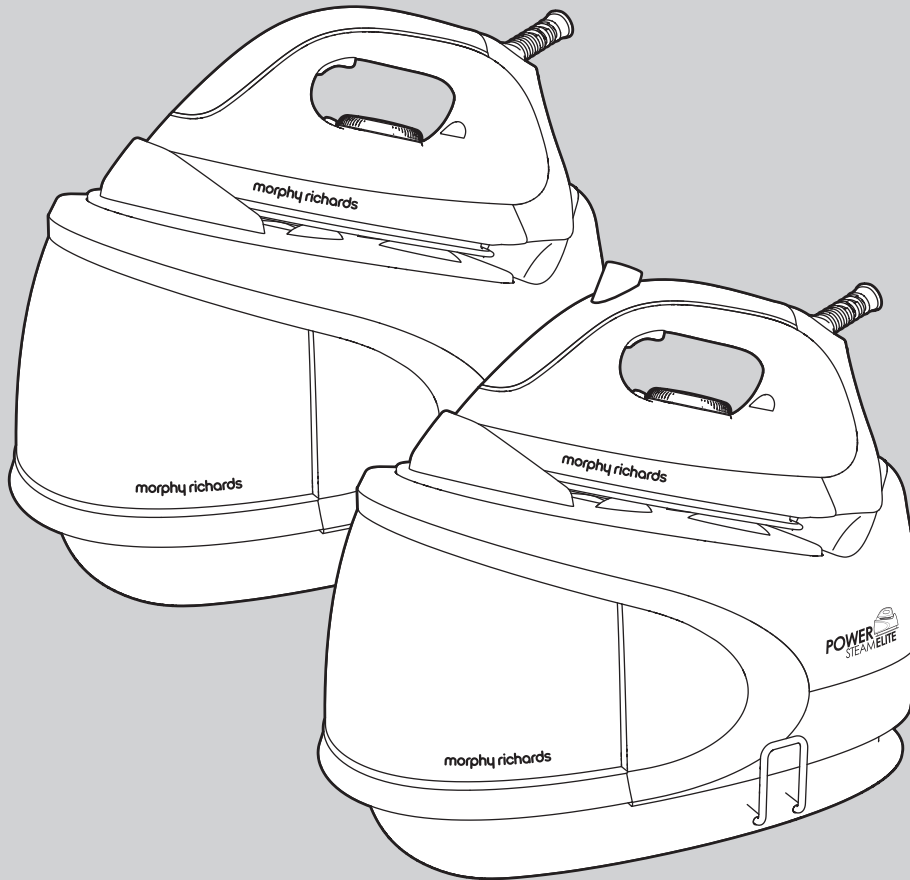

For competitions, product hints and tips
and more join us at



www.morphyrichards.co.uk/blog



www.facebook.com/morphyrichardsuk



[@loveyourmorphy](https://twitter.com/loveyourmorphy)

www.morphyrichards.com

* Register online for your 2 year guarantee. See back of this instruction book for details. (UK and Ireland customers only)

Important safety instructions

- This appliance can be used by children aged from 8 years and above and persons with reduced physical, sensory or mental capabilities or lack of experience or knowledge if they have been given supervision or instruction concerning use of the appliance in a safe way and understand the hazards involved. Children shall not play with the appliance. Cleaning and user maintenance shall not be made by children without supervision.
- Keep the steam generator and its cord out of reach of children less than 8 years of age at all times.
- The steam generator must not be left unattended while it is connected to the supply mains.
- The steam generator must be used and rested on a stable surface.
- When placing the iron on the steam generator base or on its heel, ensure that the surface on which the heel or base is placed is stable.
- The steam generator is not to be used if it has been dropped, if there are visible signs of damage or it is leaking.
- The filling aperture may be opened during use, due to the design of the system.
-  **CAUTION - HOT: Burns can occur from touching hot parts, hot water or steam, or the iron rest plate.**
- **WARNING: To avoid electric shock, do not immerse appliance in water / liquid.**
- Check that the voltage on the rating plate of your appliance corresponds with your house electricity supply which must be A.C. (Alternating current).
- Do not operate with a damaged steam/supply cord or grommet, it must be replaced by the manufacturer, its service agent or similarly qualified person in order to avoid a hazard.
- Do not let the mains lead come into contact with the hot soleplate of the iron.
- Should the fuse in the mains plug require changing, a 13 amp BS1362 fuse must be fitted.
- **WARNING: This appliance must be earthed.**

Steam generator overview

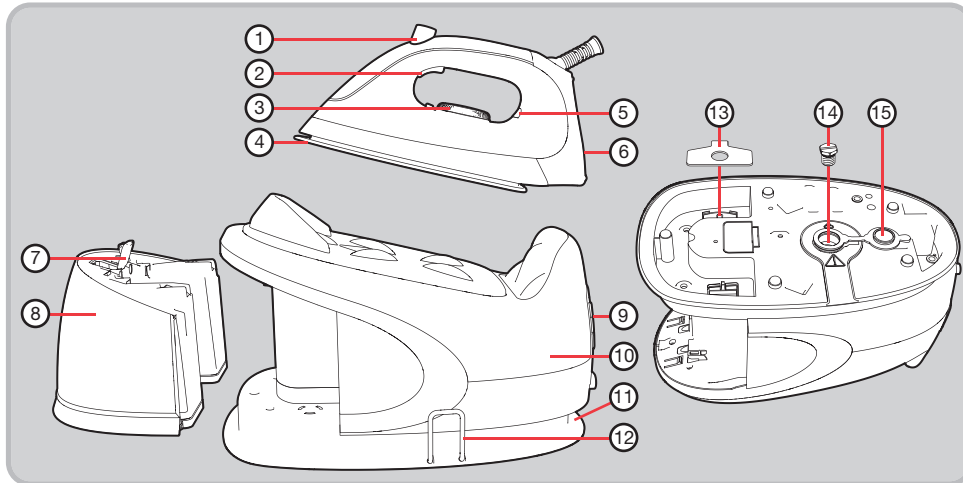

- | | | |
|--|-------------------------------|--------------------------|
| (1) Steam boost button (certain models only) | (6) Iron | (11) Cord storage groove |
| (2) Steam trigger | (7) Filling cap | (12) Cord clamp |
| (3) Temperature dial | (8) Detachable water tank | (13) Boiler key |
| (4) Soleplate | (9) Control panel (see below) | (14) Boiler screw |
| (5) Temperature indicator light | (10) Base unit | (15) Boiler cap |

Control panel (9) overview

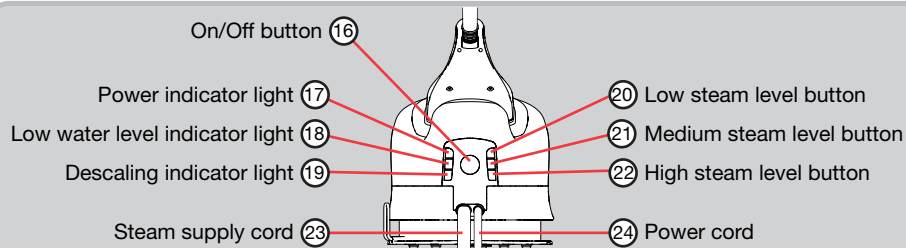

On/Off button (16) and Power indicator light (17)

Connect to a mains outlet and press the On/Off Button (16). The power indicator light (17) will illuminate and the low steam level button (20) will flash. To turn off, press and hold the On/Off Button (16) for 3 seconds. All indicator lights will go out.

Low water level indicator light (18)

If the water level is too low, the low water level indicator light (18) will illuminate. See 'Filling' on page 6.

Descaling indicator light (19)

If the boiler requires descaling, the descaling indicator light (19) will illuminate. If this happens, see 'Cleaning the boiler' on page 6.

Steam level buttons (Low 20 / Med 21 / High 22)

Press the relevant button to select your desired steam level: low (20), medium (21) or high (22). See 'Using the Steam Generator for steam ironing' on page 5.

Using the Steam Generator for steam ironing

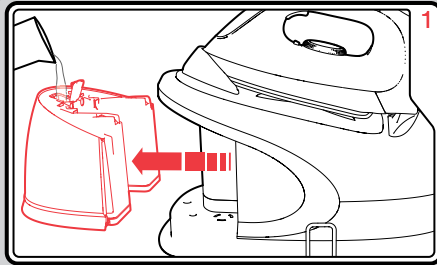

If steam ironing, remove the detachable water tank (8), lift the filling cap (7), and fill with water to the max fill line. Replace the water tank.

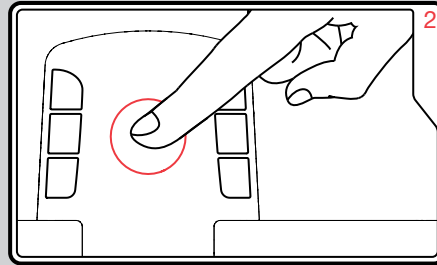

Plug the appliance into a mains outlet and press the On/Off button (16) to activate the unit.

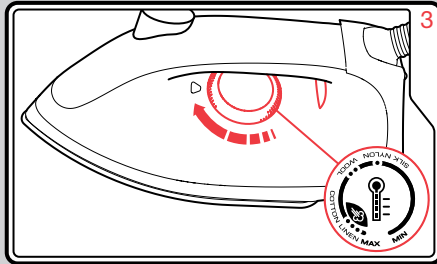

Turn the temperature dial (3) to suit the garment (see Temperature guide on page 4). The temperature indicator light (5) illuminates until the temperature is reached. Begin ironing when the temperature indicator light (5) goes out. If you turn the temperature dial (3) down, wait until the temperature indicator light (5) illuminates and then goes off again.

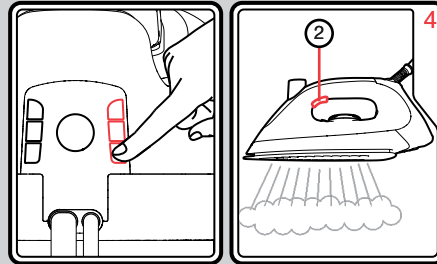

Press the relevant steam button (20/21/22) to select desired steam level. The steam button will stop flashing and illuminate constantly when the steam level is reached.

For a strong, continuous flow of steam during ironing, press and hold the steam trigger (2) to deliver steam through the soleplate.

WARNING: The steam supply cord (23) will get hot during use.

Steam boost button (certain models only)

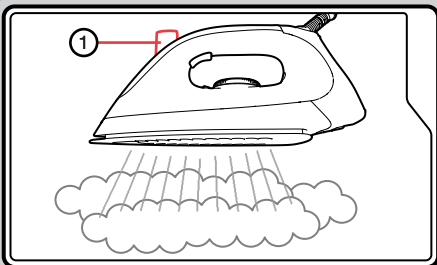

The steam boost function is ideal for relaxing the fibres of tougher fabrics (like jeans and linen) and getting rid of those stubborn, hard to reach creases.

To produce a quick, powerful shot of steam during ironing, simply press and release the steam boost button (1).

NOTE: After using the steam boost function, your steam generator iron will require up to 5 seconds to reheat before it can produce a second boost of steam. If you require a high level of constant steam, choose the appropriate steam level and use the steam trigger (2) as instructed above.

Do not combine the two steam functions. Using the two buttons together will interrupt the flow of steam and may result in the constant steam cutting out completely. For optimum steam output, use each steam function separately and as detailed above.

Filling

IN HARD WATER AREAS, WE RECOMMEND A MIX OF 50% TAP WATER AND 50% DISTILLED OR DEMINERALISED WATER.

Never use battery topping up fluid or water containing any substances like starch, sugar, fragrant additives or defrosted water from a refrigerator.

Re-filling during use

If the water level is too low, the low water level indicator light (18) will illuminate, a buzzer will sound, and the unit will not produce steam. If this happens, disconnect the water tank and refill with water.

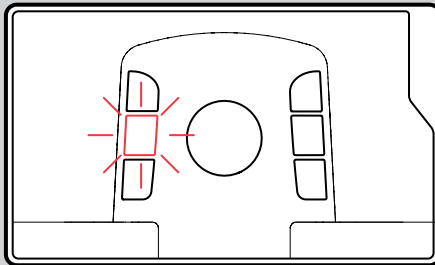

Features

Dry ironing

To use your steam generator as a dry iron only, follow steps 2 and 3 of 'Using the Steam Generator for steam ironing' on page 5. You do not need to put water in the tank or select a steam level. Press either the steam boost button (1) (certain models only) or the steam trigger (2) at least once every 10 minutes, or the product will automatically turn off.

Auto shut-off (certain models only)

If either the steam boost button (1) (certain models only) or the steam trigger (2) is unused for 10 minutes, the product will automatically turn off, both for safety and to save energy.

To restart, press the On/Off button (16) (see step 2 of 'Using the Steam Generator for steam ironing' on page 5) and wait for the temperature to rise again.

Steam function

During steaming, small amounts of water may be ejected from the soleplate. This is normal and can be avoided by using the steam for short amounts of time and only when the iron is at the correct temperature (the temperature indicator light (5) on the iron goes out when ready).

Sudden jolts of the boiler unit can also cause water droplets on the soleplate; therefore, do not move the base unit during ironing. We recommend for first time ironing that you iron over an old towel.

NOTE: The product may occasionally produce a pumping sound during steam ironing. This is normal and is caused by water being pumped through the steam generator.

Vertical steam

Vertical steam is useful for removing creases from hanging clothes, curtains, wall hangings, etc. Hold the iron between 1cm and 2cm away from the item and press either the steam boost button (1) (certain models only) or the steam trigger (2).

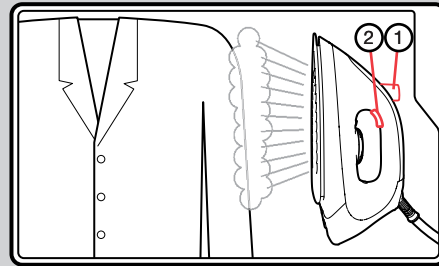

WARNING: Do not use the vertical steam feature on clothes that are being worn.

Maintenance

Cleaning the boiler

When the boiler requires descaling, the descaling indicator light (19) will illuminate. When this happens, the boiler must be manually rinsed out with clean water until all the scale is removed. The indicator light will go out only after the scale has been removed.

WARNING: Never remove the boiler screw (14) when the steam generator is hot.

- 1 Unplug the appliance from the mains outlet and leave to cool for two hours.
- 2 Remove the detachable water tank (8) and rest the iron (6) on its heel on a firm surface next to a sink.

- 3 Hold the base unit (10) firmly with both hands and shake well.
- 4 Turn the base unit (10) upside-down and pull back the boiler cap (15). Unscrew the boiler screw (14) with the boiler key (13), which is attached to the underside of the base unit. If the screw is a bit too tight to undo, try using a large screwdriver or a socket and wrench set for more leverage.

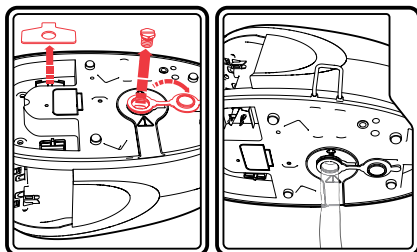

- 5 Hold the base unit (10) over the sink, turn the unit the correct way up to empty all water and loose scale from the boiler into the sink.
- 6 Using clean water, refill and empty the boiler repeatedly until all scale has been rinsed out.
- 7 Replace the boiler screw, ensuring it is tightened fully. Replace the boiler cap, boiler key, water tank and iron to the base unit.

WARNING: Ensure the boiler is empty before replacing the boiler screw (14).

- 8 The descaling indicator light (19) will extinguish the next time you use the product. Please wait for up to one minute whilst it pumps water and registers that the boiler has been cleaned.

To clean a coated soleplate

Do not use scouring powder or solution as this could cause damage to the coating.

If any man-made fibres fuse to the soleplate (4), set the iron at the MAX position and pass it over a clean piece of cotton to draw the deposit off the surface.

To clean the exterior

Allow the unit to cool and wipe over with a damp cloth and mild detergent, then wipe dry.

Emptying and storing

Allow the appliance to cool. Empty the water from the water tank (8) by removing it from the base unit (10) and opening the filling cap (7). Once the water tank is empty, re-attach it to the base unit.

If the steam generator is not going to be used for a long time, also empty the boiler as instructed, see 'Cleaning the boiler' on page 6.

To store, pull the cord clamp (12) outwards. Wrap the power cord (24) and steam supply cord (23) around the base unit in the cord storage groove (11). Secure the cord in place with the cord clamp (12). Avoid kinking of cables, particularly at the exit from the base unit.

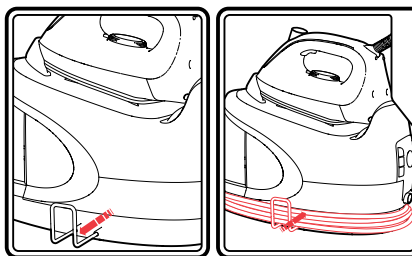

Contact us

Helpline

If you are having a problem with your appliance, please call our Helpline, as we are more likely to be able to help than the store you purchased the item from. Please have the product name, model number and serial number to hand when you call to help us deal with your enquiry quicker.

UK Helpline: 0844 871 0960

IRE Helpline: 1800 409 119

Spares: 0844 873 0726

Talk To Us

If you have any questions or comments, or want some great tips to help you get the most out of your products, join us online:

Blog: www.morphyrichards.co.uk/blog

Facebook: www.facebook.com/morphyrichardsuk

Twitter: @loveyourmorphy

Website: www.morphyrichards.com

RN42221MUK Rev4 07/13

Registering your 2 year guarantee

Your standard 1 year guarantee is extended for an additional 12 months when you register the product within 28 days of purchase with Morphy Richards. If you do not register the product with Morphy Richards within 28 days, your product is guaranteed for 1 year. To validate your 2 year guarantee register with us online at

www.morphyrichards.co.uk

Or call our customer registration line

UK 0844 871 0962

IRE 1800 409 119

N.B. Each qualifying product needs to be registered with Morphy Richards individually.

Please note that the 2 year guarantee is only available in the UK and Ireland. Please refer to the 1 year guarantee for more information.

Your 1 year guarantee

It is important to retain the retailer's receipt as proof of purchase. Staple your receipt to this back cover for future reference.

Please quote the following information if the product develops a fault. These numbers can be found on the base of the product.

Model no.

Serial no.

All Morphy Richards products are individually tested before leaving the factory. In the unlikely event of any appliance proving to be faulty within 28 days of purchase, it should be returned to the place of purchase for it to be replaced.

If the fault develops after 28 days and within 12 months of original purchase, you should contact the Helpline number quoting Model number and Serial number on the product, or write to Morphy Richards at the address shown.

You may be asked to return a copy of proof of purchase.

Subject to the exclusions set out below (see Exclusions), the faulty appliance will then be repaired or replaced as appropriate and dispatched usually within 7 working days of receipt.

If, for any reason, this item is replaced or repaired during the 1 year guarantee period, the guarantee on the new item will be calculated from original purchase date. Therefore it is vital to retain your original till receipt or invoice to indicate the date of initial purchase.

To qualify for the 1 year guarantee, the appliance must have been used according to the instructions supplied. For example, water should be emptied after each use.

Exclusions

Morphy Richards shall not be liable to replace or repair the goods under the terms of the guarantee where:

- 1 The fault has been caused or is attributable to accidental use, misuse, negligent use or used contrary to the manufacturer's recommendations or where the fault has been caused by power surges or damage caused in transit.
 - 2 The appliance has been used on a voltage supply other than that stamped on the products.
 - 3 Repairs have been attempted by persons other than our service staff (or authorised dealer).
 - 4 The appliance has been used for hire purposes or non domestic use.
 - 5 The appliance is second hand.
 - 6 Morphy Richards reserves the right not to carry out any type of servicing under the guarantee at its discretion
 - 7 Plastic filters for all Morphy Richards kettles and coffee makers are not covered by the guarantee.
 - 8 Batteries and damage from leakage are not covered by the guarantee.
- This guarantee does not confer any rights other than those expressly set out above and does not cover any claims for consequential loss or damage. This guarantee is offered as an additional benefit and does not affect your statutory rights as a consumer. Morphy Richards products are intended for household use only. See usage limitations within the location safety instructions.

Disclaimer

Morphy Richards has a policy of continuous improvement in product quality and design. The company, therefore reserves the right to change the specification of its models at any time.



For electrical products sold within the European Community. At the end of the electrical products useful life, it should not be disposed of with household waste.

Please recycle where facilities exist. Check with your Local Authority or retailer for recycling advice in your country

**IF YOU ARE HAVING A PROBLEM
WITH ONE OF OUR PRODUCTS,
CALL OUR HELPLINE:**

**UK: 0844 871 0960
EIRE: 1800 409 119
SPARES: 0844 873 0726**

morphy richards

The After Sales Division
Morphy Richards Ltd
Mexborough,
South Yorkshire,
England, S64 8AJ

www.morphyrichards.com

